

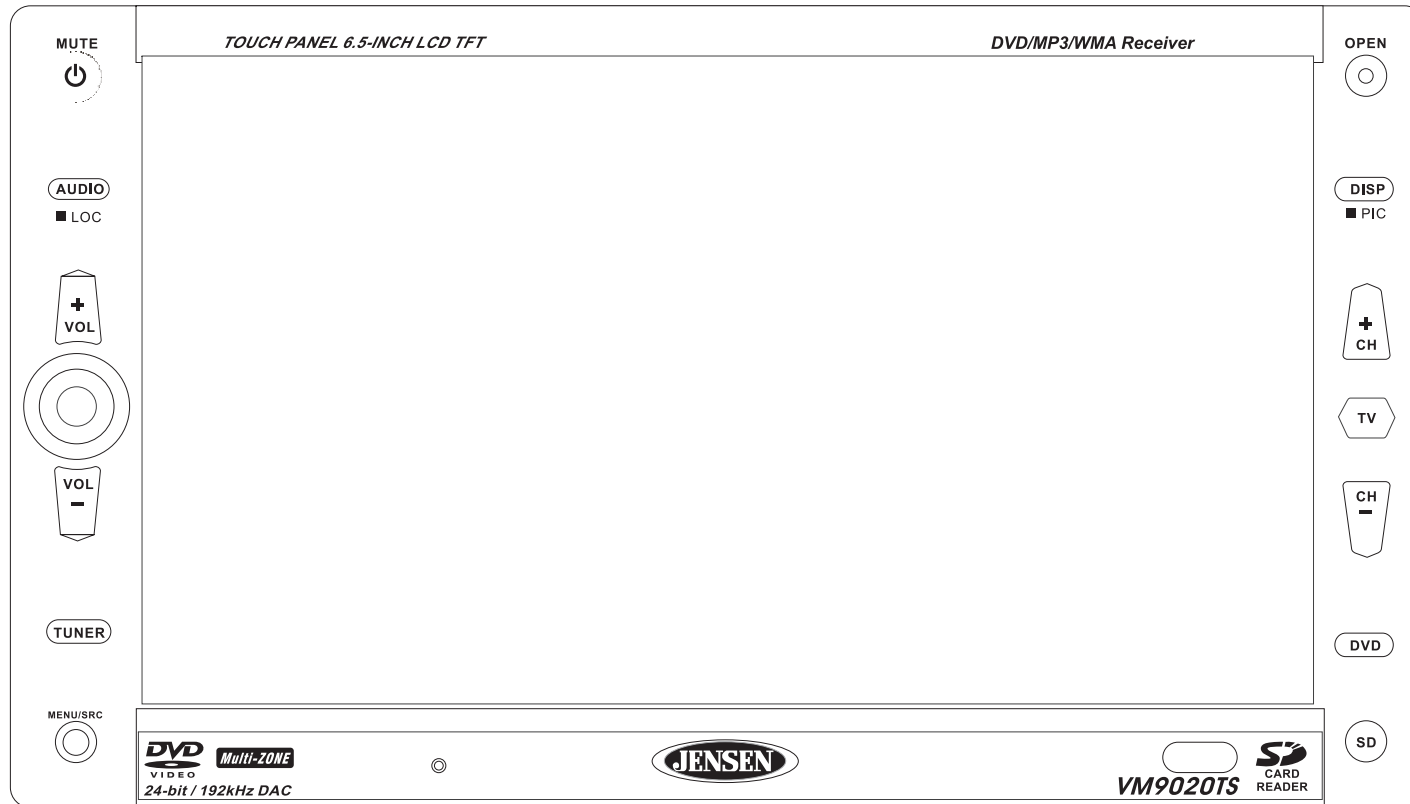

# VM9020TS Operation Manual



# CONTENTS

Thank you for choosing a Jensen product. We hope you will find the instructions in this owner's manual clear and easy to follow. If you take a few minutes to look through it, you'll learn how to use all the features of your new Jensen VM9020TS Mobile Multimedia DVD/MP3/WMA Receiver for maximum enjoyment.

<b>Preparation</b> .....	<b>1</b>	Opening/Closing the TFT Video Screen .....	14
Features .....	1	Insert/Eject Disc .....	14
Tools and Supplies .....	1	Ejecting a Disc .....	14
Disconnecting the Battery .....	1	Reset the Loading Mechanism.....	14
<b>Installation</b> .....	<b>2</b>	Accessing DVD Mode .....	14
Using the Cosmetic Trim Ring .....	2	Using the Touch-Screen Controls .....	14
Replacing the Fuse .....	2	Controlling Playback .....	14
<b>Wiring</b> .....	<b>3</b>	Accessing the DVD Menu .....	14
<b>Controls and Indicators</b> .....	<b>4</b>	Moving Through Chapters.....	14
<b>Controls and Indicators</b> .....	<b>5</b>	Fast Forward/Fast Reverse.....	15
<b>Front ZONE Remote Control</b> .....	<b>6</b>	Scanning .....	15
<b>Multi-Zone Remote Control</b> .....	<b>8</b>	Selecting 2-Channel and 6-Channel Audio Playback .....	15
<b>Using the TFT Monitor</b> .....	<b>9</b>	Goto Search .....	15
Open/Close TFT Monitor.....	9	Direct Chapter / Track Selection .....	15
TFT Monitor Auto Open .....	9	Viewing an Alternate Picture Angle (DVD Only) .....	15
Monitor Tilt Angle Adjustment .....	9	Zooming .....	15
Rear Camera Mode.....	9	Multi-Language Discs (DVD Only) .....	15
Aspect Ratio .....	9	PBC (Play back Control) (VCD Only).....	15
Image Setting .....	9	Playback Information.....	15
Parking Brake Inhibit.....	9	General Disc Information .....	16
Monitor Movement Mechanism .....	9	<b>DVD Setup Menu</b> .....	<b>17</b>
<b>Operating Instructions</b> .....	<b>10</b>	Accessing the DVD Setup Screen .....	17
Power On / Off .....	10	LANGUAGE Menu .....	17
Audible Beep Confirmation .....	10	VIDEO Menu .....	17
Mute .....	10	AUDIO Menu .....	18
Playing Source Selection .....	10	SURR SETUP Menu .....	18
Volume Adjustment.....	10	SURROUND FX.....	18
Audio Control Menu .....	10	RATING (Parental Lock) Menu .....	19
Six-Channel Audio Control.....	10	<b>CD/MP3/WMA Operation</b> .....	<b>20</b>
Rear Zone .....	10	CD Player User Interface .....	20
System Reset.....	10	MP3/WMA Discs .....	20
Line Mute .....	10	<b>SD Card Reader Operation</b> .....	<b>21</b>
<b>System Setup Menu</b> .....	<b>11</b>	Accessing SD Card Mode .....	21
General Setup Menu .....	11	Using the Touch-Screen Controls .....	21
ASP (Audio Sound Processing) Config Menu.....	11	Controlling Playback .....	21
Exiting the System Setup Menu .....	12	Moving Through Chapters.....	21
<b>Multi-ZONE Operation</b> .....	<b>12</b>	Change Directory .....	21
<b>Tuner Operation</b> .....	<b>13</b>	Previous/Next Page .....	21
Tuner TFT Display .....	13	Direct Chapter / Track Selection .....	21
Switch to Radio Tuner source.....	13	<b>TV TUNER Operation</b> .....	<b>22</b>
Select FM/AM Band .....	13	Accessing TV Mode .....	22
Auto Tuning.....	13	Auto Tuning.....	22
Manual Tuning .....	13	Manual Tuning .....	22
Using Preset Stations.....	13	Storing Stations (AS).....	22
Auto Store (AS).....	13	Direct Channel Selection.....	22
Local Radio Station Seeking (LOC) .....	13	Display Current Channel .....	22
<b>DVD Player Operation</b> .....	<b>14</b>	<b>Troubleshooting</b> .....	<b>23</b>
		Error Messages .....	24
		Care and Maintenance.....	24
		<b>Specifications</b> .....	<b>25</b>
		CEA Power Ratings .....	25
		<b>12-Month Limited Warranty</b> .....	<b>26</b>

## PREPARATION

Congratulations on your purchase of the Jensen VM9020TS Mobile Multimedia AM/FM/DVD Receiver.

It's a good idea to read all of the instructions before beginning the installation. We recommend having your Jensen VM9020TS installed by a reputable installation shop.

### Features

- ISO Double-DIN chassis
- Light weight proprietary DVD core mechanism
- Wide screen (16:9) 6.5" TFT touch screen monitor
- 280 watts total system power
- Center channel speaker output - 1 X 22 watts RMS, 40 watts peak
- Multi-Zone media distribution
- AM / FM Tuner
- TV Tuner w/diversity antenna's
- Supports NTSC and PAL, auto negotiation
- Full, Wide, Normal and Off (Standby) screen modes
- Motorized TFT panel has 16 precise angle adjustments via remote control or infinitely variable manual adjustment from the front panel
- Auto-activated rear view camera input - Reverse gear over rides the TFT screen to display video from a rear mounted camera
- Over current motor protection for obstructed TFT panel
- Compatible optical / SD Card formats: DVD-R/RW, DVD+R/RW, CD-R/RW, CD-DA, MP3, WMA, HDCD, SVCD, VCD, MPEG (MPEG 1), MPEG 4, JPEG, MP3/ WMA files burned onto a DVD+R/RW or DVD-R/RW and Kodak Picture CD
- SD Card slot
- Multi-language, multi-subtitle and multi-angle playback options
- Last position memory for optical disc.
- Parental Lock - Uses a password and disc rating set-up to prevent unauthorized user access from display content
- Audio Mute
- 5-Way joystick navigation
- Two remote controls - a full function front remote control and a limited function Kid-Zone remote control for back seat operation
- Over and under voltage protection to insure the unit operates within designed parameters
- Damped DVD mechanism with 16Mbit flash memory ESP (Electronic Shock Protection) provide smooth disc playback under the severest road conditions

### Tools and Supplies

You will need these tools and supplies to install your VM9020TS:

- Torx type, flat-head and Philips screwdrivers
- Wire cutters and strippers
- Tools to remove existing radio (screwdriver, socket wrench set or other tools)
- Electrical tape
- Crimping tool
- Volt meter/test light
- Crimp connections
- 18 gauge wire for power connections
- 16 – 18 gauge speaker wire

---

**WARNING! Only connect the unit to a 12-volt power supply with proper grounding.**

---



---

**WARNING! Never install this unit where operation and viewing could interfere with safe driving conditions.**

---



---

**WARNING! To reduce the risk of a traffic accident (except when using for rear view video camera) never use the video display function while driving the vehicle. This is a violation of federal law.**

---



---

**WARNING! Never disassemble or adjust the unit without the assistance of a professional. For details, please consult your local car stereo specialty shop.**

---



---

**WARNING! To prevent injury from shock or fire, never expose this unit to moisture or water.**

---



---

**WARNING! Never use irregular discs.**

---



---

**WARNING! To prevent damage to the mechanism inside this unit, avoid impact to the TFT monitor.**

---



---

**WARNING! To prevent damage to the touch screen display, do not use metal, plastic or any other object to attempt to operate the touch screen functions. The touch screen function was designed for hand/finger operation only.**

---



---

**WARNING! The monitor employs an automatic motorized mechanism. To prevent damage to the core mechanism, please do not push, pull or swivel the monitor manually.**

---

### Disconnecting the Battery

To prevent a short circuit, be sure to turn off the ignition and remove the negative (-) battery cable prior to installation.

---

**NOTE: If the VM9020TS is to be installed in a car equipped with an on-board drive or navigation computer, do not disconnect the battery cable. If the cable is disconnected, the computer memory may be lost. Under these conditions, use extra caution during installation to avoid causing a short circuit.**

---

## INSTALLATION

This unit is designed to fit into a 2.0 DIN dashboard opening, found in many imported cars. The unit has threaded holes in the chassis side panels which may be used with the original factory mounting brackets of some Toyota, Nissan, Mitsubishi, Isuzu, Hyundai and Honda vehicles to mount the radio to the dashboard. Please consult with your local car stereo specialty shop for assistance on this type of installation.

1. Remove the existing factory radio from the dashboard or center console mounting. Save all hardware and brackets as they will be used to mount the new radio.
2. Remove the factory mounting brackets and hardware from the existing radio and attach them to the new radio.

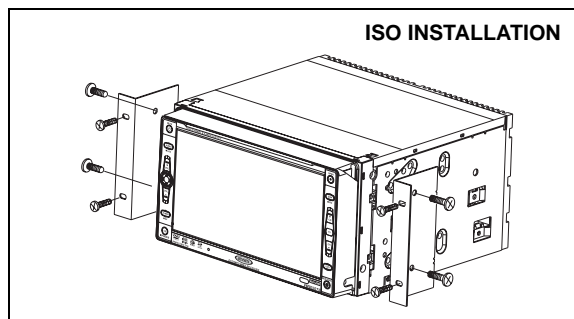

**CAUTION: Do not exceed M5 X 6 MM screw size. Longer screws may touch and damage components inside the chassis.**

3. Place the radio in front of the dashboard opening so the wiring can be brought through the mounting sleeve. Follow the wiring diagram carefully and make certain all connections are secure and insulated with wire nuts or electrical tape. After completing the wiring connections, plug the ISO connectors into the mating sockets on the rear of the chassis. Turn the unit on to confirm operation (vehicle ignition switch must be "on"). If the unit does not operate, re-check all wiring until the problem is corrected.
4. Mount the new radio assembly to the dashboard or center console using the reverse procedure in step 1.

**CAUTION: For proper operation of the CD player, the chassis must be mounted within 30° of horizontal. Make sure the unit is mounted within this limitation.**

**NOTE: It is the end-users responsibility to install and operate this unit in a manner in accordance with local, state and federal laws. The PARKING BRAKE wire MUST BE CONNECTED as directed in the manual.**

**CAUTION: Do not block the cooling fan exit. If blocked, the unit may overheat and become damaged.**

### Using the iAUX3 External AV Connector

The iAUX3 allows you to connect a variety of external devices, including a VCR, DVD player, portable MP3 player, etc., to your VM9020TS without removing the radio.

To install the iAUX3, connect it to the AUX-IN cables on the back of the VM9020TS (see "Wiring" on page 3), and then install the iAUX3 in a location convenient for plugging in auxiliary devices.

### Using the Cosmetic Trim Ring

A trim ring is packaged with the VM9020TS for installation flexibility. The VM9020TS will fit into most import dashes with little or no modification to the dash board/cavity. Some US domestic vehicle dashes will accept a Double-DIN chassis, but there is usually a small gap between the radio and dash piece after installation is complete. In this case, use the trim ring to conceal any gaps that may be present.

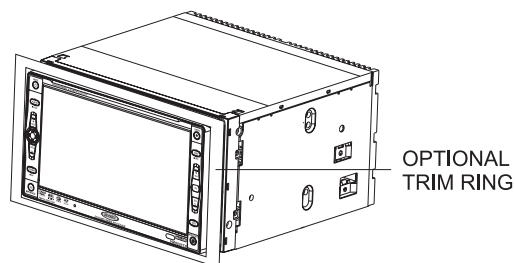

### Replacing the Fuse

When replacing the fuse, use a new 10A replacement fuse. Using a fuse with an improper rating could damage the unit and cause a fire.

# WIRING

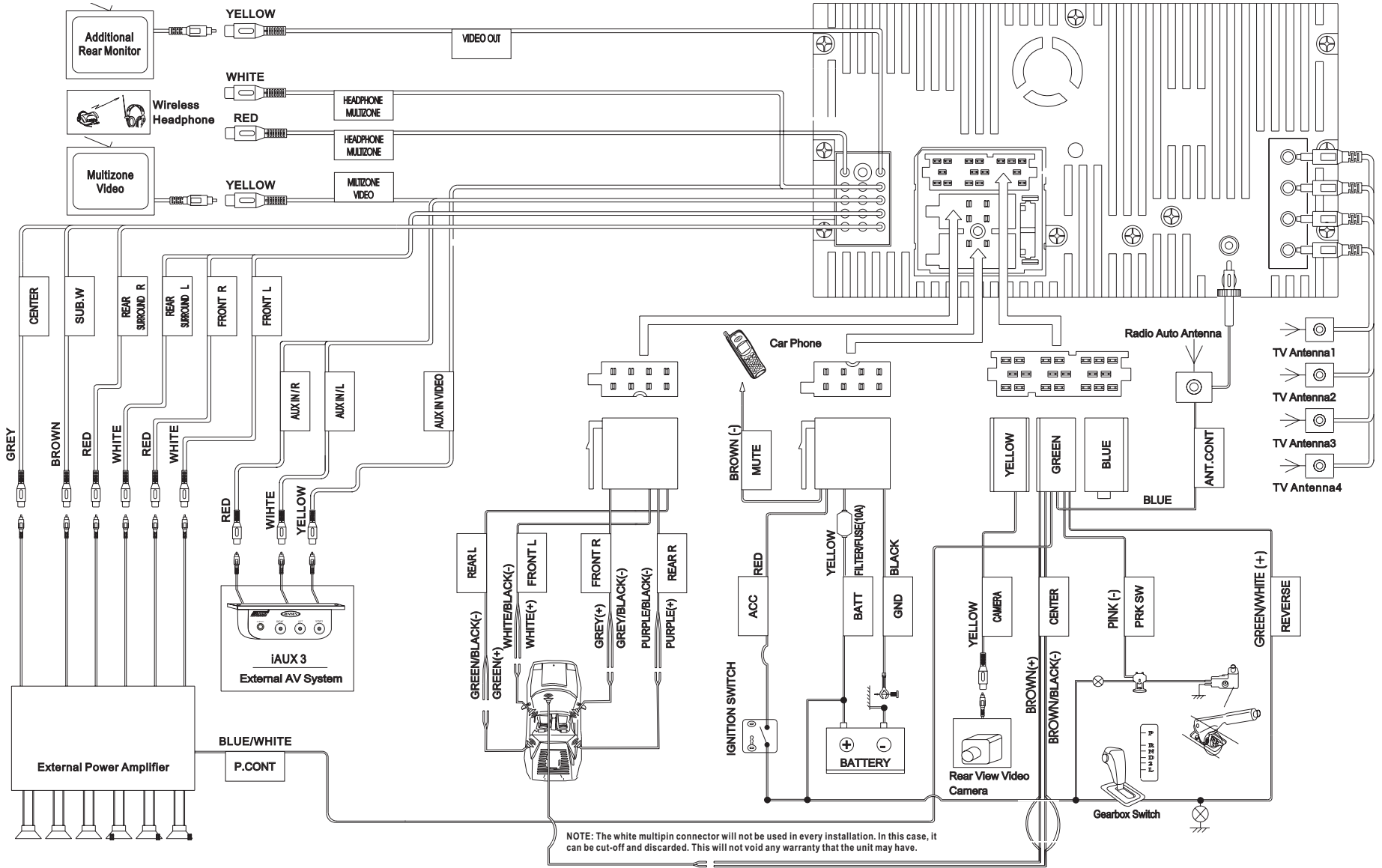

## CONTROLS AND INDICATORS

### 1. POWER/MUTE

Press the **POWER/MUTE** button (1) once to turn the unit on. Press again to mute the volume. *Press and hold* to turn the unit off.

### 2. AUDIO/LOC

Press the **AUDIO/LOC** button (2) to access the audio menu and change and/or confirm audio settings. *Press and hold* to activate or deactivate the Local (LOC) setting.

### 3. VOL +

Press to increase the volume.

### 4. VOL -

Press to decrease the volume.

### 5. Joystick/ENTER

Press in on the joystick to perform the “enter” function during various applications. Push the key up, down, left or right to perform the following tasks:

#### 6. Joystick/▲

- DVD Mode: Press once for fast forward/fast reverse.
- TUNER Mode: Press to go up one frequency step.
- MENU Mode: Press once to move the cursor up.
- TV Mode: Press once to select a stored TV channel.

#### 7. Joystick/▼

- DVD Mode: Press once for slow forward/slow reverse.
- TUNER Mode: Press to go down one frequency step.
- MENU Mode: Press once to move the cursor down.
- TV Mode: Press once to select a stored TV channel.

#### 8. Joystick/◀

- DVD Mode: Press once to play back previous chapter/track.
- TUNER Mode: Press once to auto search for the previous available radio station. Press and hold to increase the tuner frequency step-by-step.
- MENU Mode: Press once to move the cursor to the left.
- TV Mode: Press to go down one frequency step.

#### 9. Joystick/▶

- DVD Mode: Press once to enter the next chapter or track.
- TUNER Mode: Press once to auto-search the next available radio station. Press and hold to decrease the tuner frequency step-by-step.
- MENU Mode: Press once to move the cursor to the right.
- TV Mode: Press to go up one frequency step.

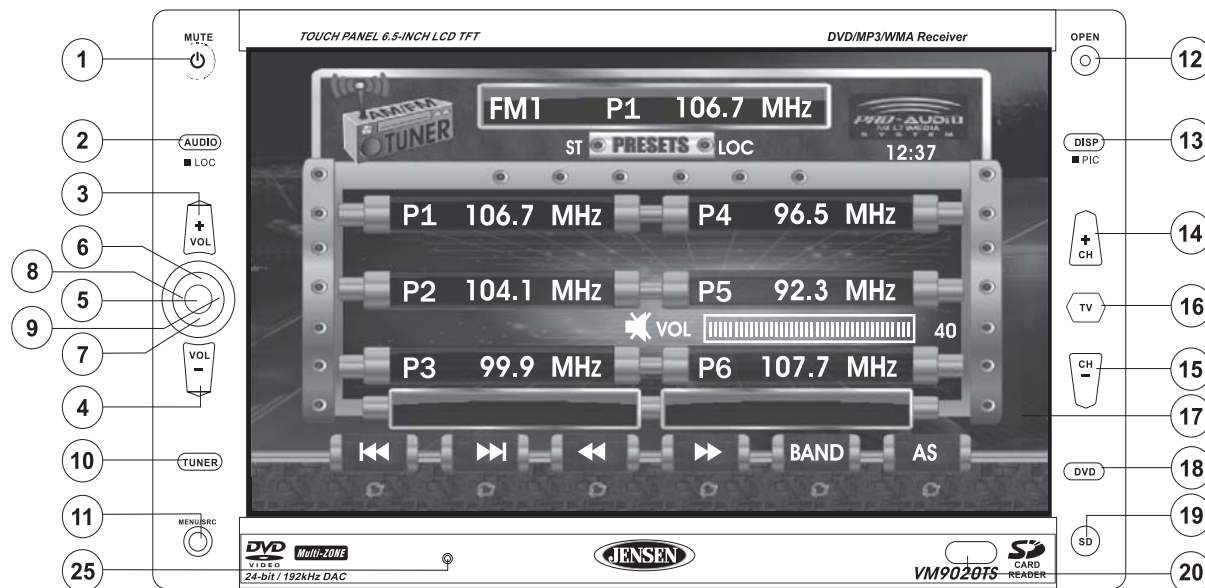

### 10. TUNER

Press to access the radio tuner source and then to change between AM and FM bands.

### 11. MENU/SRC

Press to access the playing source menu.

### 12. OPEN

Press the **OPEN** button (12) to activate the automatic mechanical system and move the TFT down, exposing the disc and SD card slots. Press again to close the TFT.

### 13. DISP/PIC

Press the **DISP/PIC** button (13) to adjust the display aspect of the picture to one of three settings: Wide, Full or Normal. Press and hold to access picture settings.

### 14. CH+

- Press and hold the **CH+** button (14) to adjust the monitor position upright.
- Press to play the next preset AM/FM station.
- Press to play the next stored TV channel.

### 15. CH-

- Press and hold the **CH-** button (15) to adjust the monitor position outward.
- Press to play the previous preset AM/FM station.
- Press to play the previous stored TV channel.

### 16. TV

Press to access the TV tuner source.

### 17. TFT Display

### 18. DVD

Press the access the DVD player source.

### 19. SD

- Press to access the SD card source.

### 20. IR Remote Control Receiver

## CONTROLS AND INDICATORS

**21. Disc Slot**

**22. Eject Button**

- Press once to eject the disc.
- Press and hold to reset the mechanism.

**23. Disc Indicator**

**24. SD Card Slot**

**25. Reset Button (see page 4).**

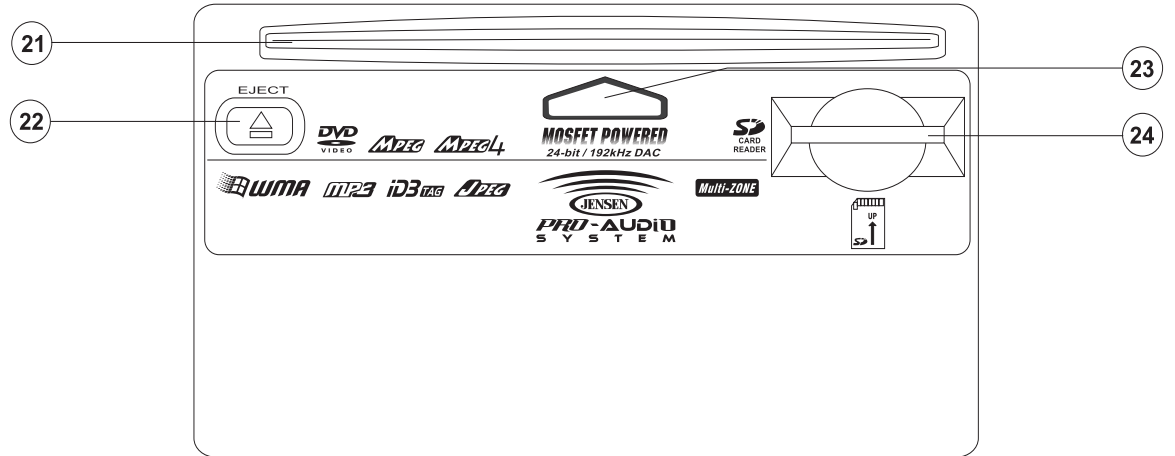

# FRONT ZONE REMOTE CONTROL

**Table 1: Front Zone Remote Control Functions**

Button		Function			
Name	Ref #	DVD	VCD	TUNER	CD/MP3
MENU	1	Enters the main menu of the disc	Turns on PBC when playing VCD		
TITLE	2	Enters the title menu of the disc	Plays first ten seconds of each chapter/title		
MUTE/	4	Turns the power on. Toggles on/off audio output. Press and hold to turn the power off.	Turns the power on. Toggles on/off audio output. Press and hold to turn the power off.	Turns the power on. Toggles on/off audio output. Press and hold to turn the power off.	Turns the power on. Toggles on/off audio output. Press and hold to turn the power off.
AUDIO	5	Changes the audio language for disc playback	Changes the audio language for disc playback		
REPT A-B	6	Setup to repeat playback from time frame A to time frame B	Setup to repeat playback from time frame A to time frame B		
REPT	7	Repeats playback of current chapter	Repeats playback of current chapter		Repeats playback of current track
SRC	8	Selects front zone playback source	Selects front zone playback source	Selects front zone playback source	Selects front zone playback source
SUBTITLE	9	Language selection for subtitle			
DISP	10	Displays playing information	Displays playing information	Displays playing information	Display playing information
ANGLE ▲	11	Continuously adjusts front panel tilt angle	Continuously adjusts front panel tilt angle	Continuously adjusts front panel tilt angle	Continuously adjusts front panel tilt angle
ANGLE ▼	12	Continuously adjusts front panel tilt angle	Continuously adjusts front panel tilt angle	Continuously adjusts front panel tilt angle	Continuously adjusts front panel tilt angle
ANGLE	13	Plays back disc in different angle for a scene	Plays back Picture CD with different angle of picture displayed		
▶▶	14	Fast forwards the disc content	Fast forwards the disc content	Fast forwards the disc content	Fast forwards the disc content
VOL -	15	Decreases volume	Decreases volume	Decreases volume	Decreases volume
VOL +	16	Increases volume	Increases volume	Increases volume	Increases volume
◀◀	17	Selects the previous chapter for playback	Selects the previous chapter for playback	Searches an available radio station by decreasing tuning frequency	Selects the previous track for playback
▶/	18	Pauses playback/starts playback	Pauses playback/starts playback	Scans FM/AM radio station; plays/stores radio station; deletes radio station	Pauses playback/starts playback
▶▶	19	Selects the next chapter for playback	Selects the next chapter for playback	Searches an available radio station by increasing tuning frequency	Selects the next track for playback
■/BAND	20	Stops playback	Stops playback	Selects FM/AM band	Stops playback
GOTO	21	Goes to specific time frame and playback	Goes to specific time frame and playback		
▶	22	Slow playback/slow rewind playback	Slow playback/slow rewind playback		
ZOOM	23	Zooms in/out on an image	Zooms in/out on an image		

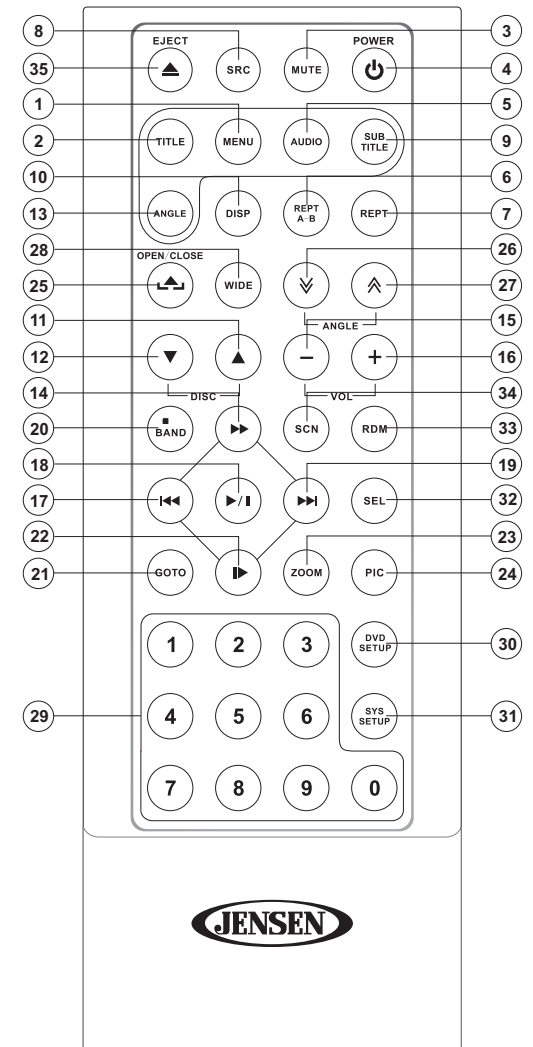

**NOTE: Your remote control may differ slightly from the one pictured here. The above diagram is for illustrative purposes only.**



**Table 1: Front Zone Remote Control Functions**

Button		Function			
Name	Ref #	DVD	VCD	TUNER	CD/MP3
PIC	24	Displays set-up parameters	Displays set-up parameters		
OPEN/CLOSE	25	Opens/Closes the TFT monitor	Opens/Closes the TFT monitor	Opens/Closes the TFT monitor	Opens/Closes the TFT monitor
∨	26	Decreases monitor tilt angle	Decreases monitor tilt angle	Decreases monitor tilt angle	Decreases monitor tilt angle
∧	27	Increases monitor tilt angle	Increases monitor tilt angle	Increases monitor tilt angle	Increases monitor tilt angle
WIDE	28	Selects display mode: WIDE, NORMAL, or FULL	Selects display mode: WIDE, NORMAL, or FULL	Selects display mode: WIDE, NORMAL, or FULL	Selects display mode: WIDE, NORMAL, or FULL
0, 1, 2, 3, 4, 5, 6, 7, 8, 9, 0 (Numeric Keypad)	29	Directly accesses chapter		1-6 selects preset for current band	Directly accesses track
DVD SETUP	30	Access DVD Setup menu	Access DVD Setup menu	Access DVD Setup menu	Access DVD Setup menu
SYS SETUP	31	Access System Setup menu	Access System Setup menu	Access System Setup menu	Access System Setup menu
SEL	32				
RDM	33	Plays all chapters in random order			Plays all tracks in random order
SCN	34				Plays the first ten seconds of each track
EJECT	35	Ejects disc	Ejects disc	Ejects disc	Ejects disc

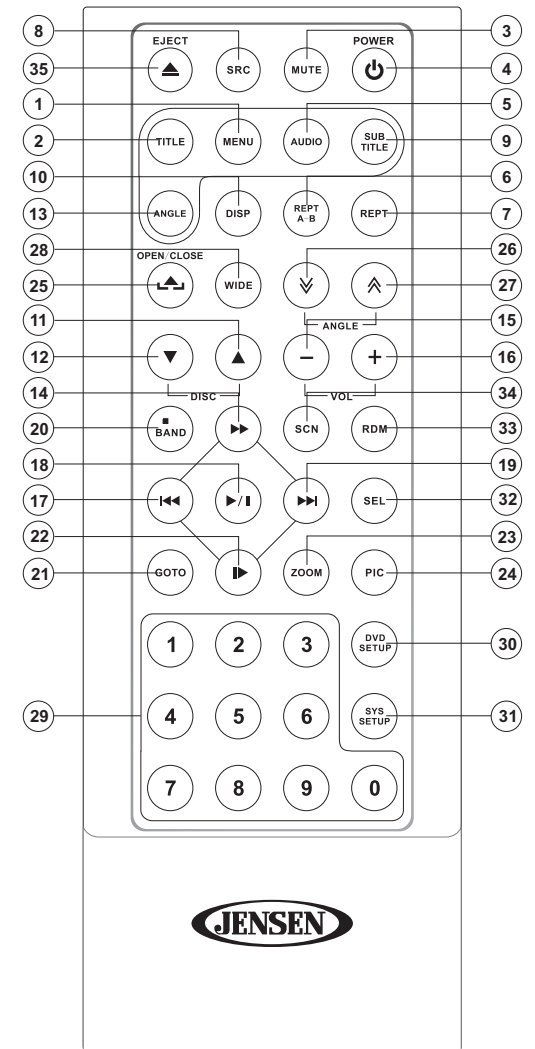

**NOTE: Your remote control may differ slightly from the one pictured here. The above diagram is for illustrative purposes only.**

## MULTI-ZONE REMOTE CONTROL

Table 2: Multi-Zone Remote Control Functions

Button		Function	
Name	Ref #	DVD	VCD
MENU	1	Enters the main menu of the disc	Turns on PBC when playing VCD
TITLE	2	Enters the title menu of the disc	Plays first ten seconds of each chapter/title
MUTE	3	Toggles on/off audio output	Toggles on/off audio output
AUDIO	5	Switches the audio language for disc playback	
REPT	7	Setup to repeat playback of each chapter/title/disc	Setup to repeat playback of each chapter/title/disc
R.SRC	8	Selects playing mode for rear zone	Selects playing mode for rear zone
SUBTITLE	9	Language selection for subtitle	
▶▶	14	Fast forwards the disc content	Fast forwards the disc content
◀◀	17	Selects the previous track/chapter for playback	Selects the previous track/chapter for playback
▶/	18	Pauses playback/Starts playback	Pauses playback/Starts playback
▶▶	19	Selects the next track/chapter for playback	Selects the next track/chapter for playback
GOTO	21	Goes to specific time frame and playback	Goes to specific time frame and playback
▶	22	Slow playback/slow rewind playback	Slow playback/slow rewind playback
0, 1, 2, 3, 4, 5, 6, 7, 8, 9, 0 (Numeric Keypad)	29	Directly accesses chapter	

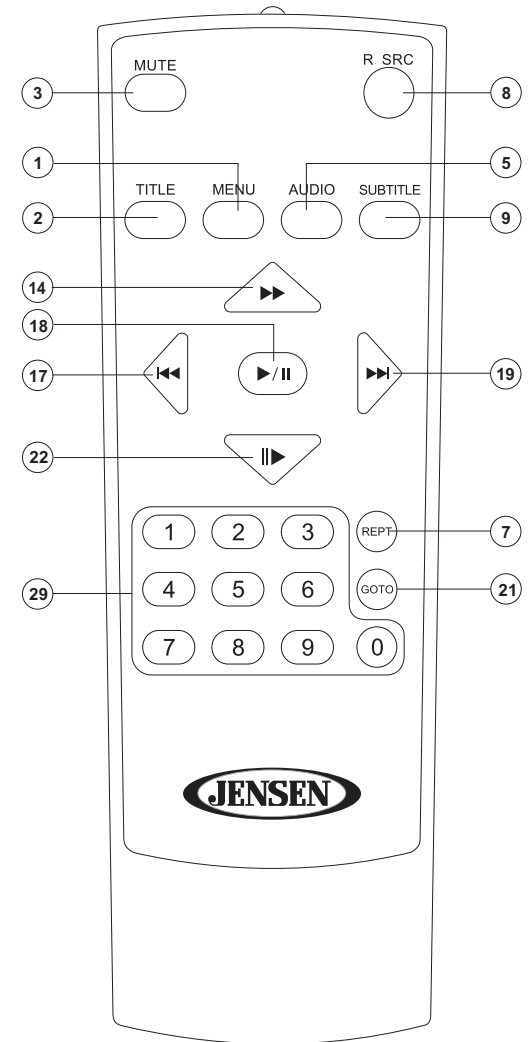

**NOTE:** Your remote control may differ slightly from the one pictured here. The above diagram is for illustrative purposes only.

## USING THE TFT MONITOR

### Open/Close TFT Monitor

#### Open TFT Monitor

Press the **OPEN** button (12) on the front panel or press the (▲) button (25) of the front zone remote control to open/close the monitor.

#### TFT Monitor Auto Open

- If "TFT Auto Open" is "on" when the unit is turned on, the monitor automatically moves to the last viewing position.
- If "TFT Auto Open" is "off" when the unit is turned on, press the **OPEN** button (12) or (▲) button (25) on the front zone remote control to move the monitor into the desired viewing position.

### Monitor Tilt Angle Adjustment

A known characteristic of LCD panels is the quality of the display in relationship to the viewing angle. The monitor angle can be adjusted for optimum viewing using one of the following methods:

- Press the (⤴) or (⤵) button (3, 4) on the remote control or the **CH+** or **CH-** button (14, 15) on the front of the unit to adjust the tilt angle of the screen one step at a time.
- Press and hold the to adjust the tilt angle of the screen one step at a time.

### Rear Camera Mode

When the vehicle is placed in "Reverse", and an optional rear camera is connected to the VM9020TS, the TFT monitor will automatically switch to the camera input source.

### Aspect Ratio

The following sources only have the **WIDE** and **OFF** aspect ratio option: AM / FM Tuner, CD-DA, SD Card, DVD+R/RW, DVD-R/RW and CD-R/RW with music files. Press the **WIDE** button (28) on the remote control to adjust the aspect ratio as follows:

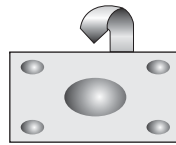

#### FULL

The entire screen is extended horizontally to the aspect ratio of 16 to 9. The extension ratio is the same at any point.

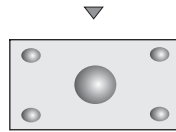

#### WIDE

The screen is extended horizontally to the aspect ratio of 16 to 9. The extension ratio increases toward the right and left ends of the screen.

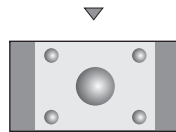

#### NORMAL

The conventional display image has a 4 to 3 ratio of horizontal to vertical, leaving a blank area on the right and left sides of the display.

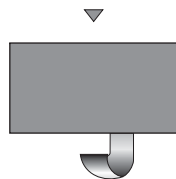

#### OFF

### Image Setting

#### Video Output Format

Table 3 shows the video output format for each playing source.

Table 3: Video Output Formats

Playing Source	Video Output Format
TUNER	RGB Mode
DVD	RGB Mode
AUX IN	CVBS Mode
CAMERA	CVBS Mode
TV	CVBS Mode

\*CVBS – Composite Video Baseband Signal

#### Adjustable Parameters

While in DVD or TUNER mode, the only parameter that can be adjusted is brightness (BRIGHT). To access "PICTURE", "COLOR", "CONTRAST", and "TINT" you must be in AUX or CAMERA mode.

**NOTE:** The default adjustment is "0" in PAL mode. Tint is unavailable for adjustment.

#### Parameter Adjustment Procedure

1. **Enter Picture Quality Setting mode:**  
Press the **PIC** button (24) on the remote or *press and hold* the **DISP/PIC** button (13) on the unit.
2. **Select Item to Set:**  
Press the (▶▶) (▶▶) buttons (14, 22) on the remote or *press and hold* the (▲) or (▼) buttons (18, 19) on the monitor panel.
3. **Set Parameters:**  
Press (◀◀) (▶▶) buttons (17, 19) on the remote or press (◀) (▶) buttons (8, 9) on the unit.
4. **Exit Picture Quality Setting Mode:**  
Press the **PIC** button (24) on the remote or *press and hold* the **DISP/PIC** button (13) on the monitor panel.

### Parking Brake Inhibit

- When the "PRK SW" cable is connected to the brake switch, the display on the TFT monitor will display video only when the vehicle is applied.
- Parking brake function is overridden when the video source is set to CAMERA.
- When the parking brake inhibit is active, the front monitor displays "Parking Is On", preventing the driver from watching content while driving. Rear video screens are not affected.

### Monitor Movement Mechanism

If an obstruction occurs in the monitor path, the motion will stop automatically to prevent damage to the mechanism or monitor.

Normal operation is resumed by pressing the **OPEN** button (12) or disconnecting and reconnecting the power.

## OPERATING INSTRUCTIONS

### Power On / Off

Press the **⏻/MUTE** button (1) to turn the unit on. The buttons on the front of the unit will light up.

Press and hold the **⏻/MUTE** button (1) on the front panel or the **POWER** button (4) on the remote to power off the unit.

### Audible Beep Confirmation

An audible beep tone confirms each function selection. The beep tone cannot be disabled.

### Mute

Press the **⏻/MUTE** button (1) on the front panel or remote (3) to mute the volume from the unit. Press the **MUTE** button again to restore the volume. The mute icon flashes on the right side of the screen. Adjusting the volume or using any of the audio set-up features cancels the mute function.

### Playing Source Selection

Press the **SRC** button (11) on the remote to change between available playing sources in the following order: TUNER, DVD, AUX IN or CAMERA (rear view video camera). The playing mode is displayed on the screen.

Press the **MENU/SRC** button (11) on the unit to access the playing source menu. Use the direction buttons on the joystick (6, 7, 8, 9) or remote control (14, 17, 18, 19, 22) to select a playing source, then press the **▶/||** button (18) or the joystick enter button (5) to enter the selected source.

### AUX IN Mode

An external peripheral device can be connected to this unit via RCA output and "AUX-IN".

### CAMERA Mode

"CAMERA" mode is only available if the camera is connected and during reverse driving. To install a rear view video camera, connect the video input cable to the camera output cable.

### Volume Adjustment

To increase the volume level, press the **VOL +** button (3) on the front panel or remote control. To decrease the volume level, press the **VOL -** button (4) on the front panel or remote control. The volume ranges from "0" to "40". When the volume level reaches "0" or "40", a triple beep sounds, indicating that the adjustment limit has been reached. The screen displays the volume level for 3 seconds.

### Programmable Turn-On Volume

This feature allows the user to select a turn-on volume setting regardless of the volume setting prior to turning the unit off.

To program a specific volume level, push and hold the **AUDIO** button (2) while the yellow volume bar is displayed on the screen. The unit will beep two times to confirm your turn-on volume setting.

### Audio Control Menu

The Audio Control feature allows you to easily adjust your audio system to meet the acoustical characteristics of your vehicle, which vary depending on the type of vehicle and its measurements. To get the best possible sound quality from your new system, be sure to adjust the settings for the speakers as well. Proper setting of the Fader and Balance boosts the effects of the cabin equalizer.

#### Accessing the Audio Control Menu

Press the **AUDIO/LOC** button (2) on the front panel to display the "AUDIO" menu.

#### Selecting an Audio Feature for Adjustment

Press the (**◀**)/(**▶**) buttons (8, 9) on the joystick or the (**◀◀**)/(**▶▶**) buttons (17, 19) on the remote control to select the audio feature to be adjusted.

#### Adjusting an Audio Feature

Press the **▶▶** or **▶▶** buttons (14, 22) on the remote control or the **▲** or **▼** buttons (6, 7) on the joystick to adjust the selected feature to the desired setting.

Table 4: Audio Adjustments

Audio Function	Adjustable Range
EQ	User
	Flat
	Jazz
	Pop
	Classical
	Rock
	Vocal
Bass	-14 to +14
Treble	-14 to +14
Fade	-9 to +9
Bal	-9 to +9
SW	-7 to +7
Loud	Off, 1-4

**NOTE: The Bass and Treble levels are only adjustable when EQ is set to "User" mode.**

The Loud function compensates for deficiencies in sound ranges at low levels. Loudness levels range from 1-4 or "off". When the Loud function is on, LOUD is displayed on the screen.

### Exiting the Audio Control Menu

Press and hold the **AUDIO/LOC** button (2) or stop making adjustments for a few seconds to exit the audio control menu.

### Six-Channel Audio Control

**NOTE: Before adjusting the volume of any speaker, please refer to "Surround Setup" on page 18.**

Table 5: 6-Channel Audio Adjustments

Item	Adjustable Range
Master Volume	00 to 40
Front Left Channel Volume	-10 to +10
Front Right Channel Volume	-10 to +10
Rear Left Channel Volume	-10 to +10
Rear Right Channel Volume	-10 to +10
Center Channel Volume	-10 to +10
Subwoofer Volume	-10 to +10

### Rear Zone

If a monitor is installed in the rear zone and connected to the rear zone AV output, passengers in the back seat can control the DVD output using the rear zone remote control. See "Multi-Zone Remote Control" on page 8 for instructions.

### System Reset

To correct a system halt or other illegal operation, use the tip of a pen to press the **RESET** button (25) located on the front bottom-left corner of the TFT screen. After a system reset, the unit restores all factory default settings.



**NOTE: If the unit is reset while a DVD is playing, the DVD resumes play once the reset is complete.**

### Line Mute

If the "MUTE" wire is connected, audio output mutes when a telephone call is received by the car phone or when verbal navigation is performed. See "Wiring" on page 3.

## SYSTEM SETUP MENU

In "System Setup" mode, "ASP CONFIG" and "GENERAL SETUP" are available for adjustment. Setup can be performed by pressing the dedicated button on the remote control or by pressing the **MENU/SRC** button (11) on the front panel.

For system settings, press the **SYS SETUP** button (31) on the remote control or touch "SETUP" on the screen to enter the "SETUP" menu. "SYS SETUP" is highlighted in green.

### General Setup Menu

#### Accessing the General Setup Menu

To access the "GENERAL SETUP" Menu, press the direction buttons on the joystick (6, 7, 8, 9) or remote control (14, 17, 18, 19, 22) to highlight "GENERAL SETUP" in green.

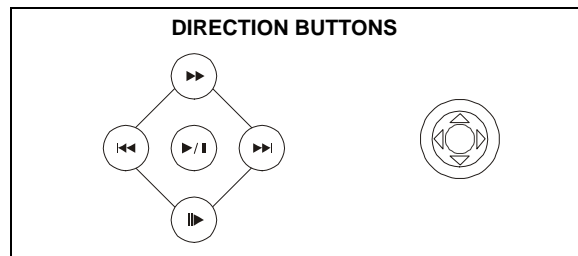

Press the **▶/||** button (18) on the remote control to enter the "GENERAL SETUP" menu. A menu appears with the option for the first item, "Radio", highlighted in light blue.

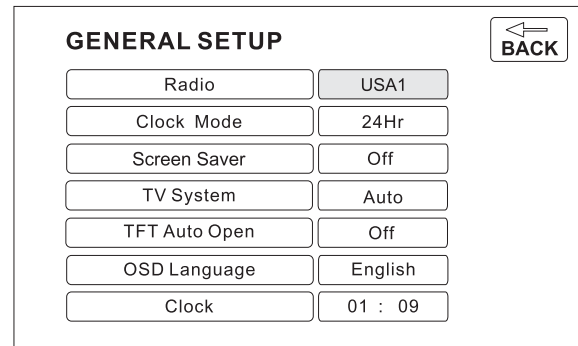

#### Selecting a Feature for Adjustment

Press the **▶▶** or **▶|** buttons (14, 22) on the remote control or the **▲** or **▼** buttons (6, 7) on the joystick to select the feature to be adjusted.

#### Adjusting a Feature

1. Enter the option field for the feature you want to adjust by pressing the **▶/||** button (18) on the remote or by pressing the **ENTER** (joystick) button (5) on the unit. A submenu appears in a second row with the selected option highlighted in light blue.
2. Select a new value by pressing the **▶▶** or **▶|** buttons (14, 22) on the remote control or the **▲** or **▼** buttons (6, 7) on the joystick.
3. Confirm your selection by pressing the **▶|**, **◀◀**, or **▶▶** buttons (14, 17, 19) on the remote control, or the **◀** or **▶** button (8, 9) on the joystick. The new value is highlighted in light blue and setup is complete.

Table 6: General Setup Menu Features

Setting	Options	Function
Radio	USA1	Select the appropriate setting based on the country in which you reside.
	S. Amer 1	
	Arabia	
	China	
	S. Amer 2	
	Korea	
Clock Mode	12H	Clock displays 12 hour time using AM and PM.
	24H	Clock displays 24 hour time up to 23:59.
Screen Saver	On	Turn screen saver on/off.
	Off	
TV System	Auto	The color signal output is switched automatically based on the current disc.
	NTSC	The color signals are output in the standard NTSC format.
	PAL	The color signals are output in the standard PAL format.
TFT Auto Open	On	The TFT panel automatically opens when the unit is turned on.
	Off	You must press the OPEN button (12) to open the TFT panel.
OSD Language	English	The menus are displayed in English only.
Clock	(HH:MM)	See "Adjusting the clock" to learn how to set the clock.
BACK		Return to previous menu.

#### Adjusting the Clock

1. Access the "Clock" setting under the General Setup menu.
2. Press the **▶▶** or **▶|** buttons (14, 22) on the remote control or the **▲** or **▼** buttons (6, 7) on the joystick to move the cursor to the "Hour" or "Min" position.
3. Press the **◀◀**, or **▶▶** buttons (17, 19) on the remote control or the **◀** or **▶** buttons (8, 9) on the joystick to adjust the hour or minutes.
4. Press the **▶** button (14) on the remote control to confirm setup.

#### Returning to the System Setup Menu

To return to the System Setup menu, move to BACK, then press the **▶/||** button (18) on the remote control.

### ASP (Audio Sound Processing) Config Menu

The ASP Config Menu allows you to make fine audio adjustments.

#### Accessing the ASP Config Menu

To access the "ASP CONFIG" Menu from the "SYSTEM SETUP" menu, press the direction buttons on the joystick (16, 17, 18, 19) or remote control (14, 17, 18, 19, 22) to highlight "ASP CONFIG" in green. Press the **▶/||** button (18) on the remote control to enter the "ASP CONFIG" menu. A menu appears with the option for the first item, "Bass Center Freq", highlighted in light blue.

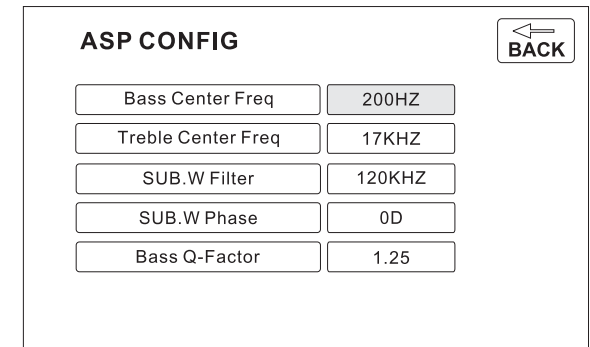

#### Adjusting a Feature

1. Enter the option field for the feature you want to adjust by pressing the **▶/||** button (18) on the remote or by pressing the **ENTER** (joystick) button (5) on the unit. A

submenu appears in a second row with the selected option highlighted in light blue.

2. Select a new value by pressing the ►► or ► buttons (14, 22) on the remote control or the ▲ or ▼ buttons (6, 7) on the joystick.
3. Confirm your selection by pressing the ►►, ◀◀, or ►► buttons (14, 17, 19) on the remote control, or the ◀ or ► button (8, 9) on the joystick. The new value is highlighted in light blue and setup is complete.

**Table 7: ASP Config Menu Features**

Setting	Options	Function
Bass Center Freq	60Hz	According to the audio source, select the Bass Center Frequency to achieve the best Bass effect.
	80Hz	
	100Hz	
	130Hz	
	150Hz	
Treble Center Freq	10KHz	According to the audio source, select the Treble Center Frequency to achieve the best Treble effect.
	12.5KHz	
	15KHz	
	17KHz	
Sub.W Filter	80Hz	Selecting a crossover frequency sets a cut-off frequency of the subwoofer's LPF (low-pass filter) and the "SMALL" speakers' HPF (high-pass filter). The Crossover frequency setting has no effect if the subwoofer is set to "OFF" and any other speaker is set to "LARGE".
	120Hz	
	160Hz	
Sub.W Phase	0D	Subwoofer output IN phase
	180D	Subwoofer output OUT OF phase
Bass Q-Factor	1.0	When the Bass Center Frequency is selected, adjusting the Bass Q-Factor alters the sharpness of the Bass output.
	1.25	
	1.5	
	2.0	
BACK		Return to previous menu.

### Exiting the System Setup Menu

To exit setup mode and resume normal playback, press the **SYS SETUP** button (31) on the remote control or the **DISP** button (13) on the front panel.

## MULTI-ZONE OPERATION

Independent sources can be played simultaneously on the VM9020TS. For example, a video game console can be seen on the front screen while DVD video is available to rear passengers. For example, DVD is selected as the front source and SD Card is selected for the rear source or SD Card is selected as the front source and DVD is selected for the rear source. In the first case, both sources will switch to SD Card. In the second case, both sources will switch to the DVD source because the multimedia processor is shared between optical and SD Card media.

### Selecting a Source for the Front Zone

To access the FRONT ZONE SOURCE MENU, touch the TFT screen in the top left corner of the screen.



This menu allows you to select a source for the front zone.

### Selecting a Source for the Rear Zone

To access the rear zone SOURCE MENU, touch the top right corner of the screen, near the Multi-ZONE icon.

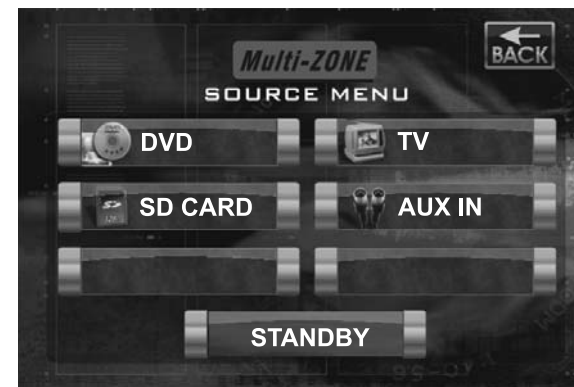

Select the source to be directed to the rear Multi-ZONE RCA outputs.

**NOTE:** Optical media and an SD Card cannot be selected from the Multi-ZONE Source Menu icon simultaneously.

**NOTE:** The AM/FM tuner graphics will change to a "blue screen" background when any optical or SD Card media is selected from the Multi-ZONE menu. In addition, only the top left (Front Zone Source Menu) and right (Multi-ZONE Source Menu) quadrants of the touch screen are active during this mode of operation.

# TUNER OPERATION

## Tuner TFT Display

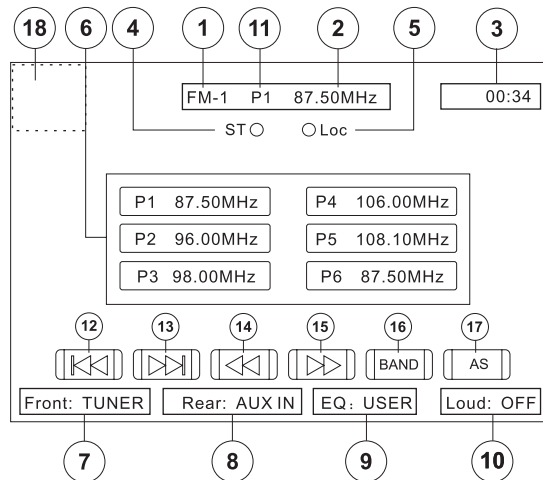

1. Current Radio Band Indicator
2. Radio Frequency Indicator
3. Clock
4. Stereo Broadcasting Indicator
5. Strong Local Signal Broadcasting Indicator: Touch and hold to activate/deactivate Local function
6. Preset Radio Stations: Touch to recall preset stations or touch and hold to store a station
7. Front Zone Playing Mode
8. Rear Zone Playing Mode
9. User Defined Equalizer Level
10. Loud Setting Indicator
11. Current Preset Station Indicator
12. ◀◀: Touch to seek backward
13. ▶▶: Touch to seek forward
14. ◀◀: Touch to tune backward one step
15. ▶▶: Touch to tune forward one step
16. **BAND**: Touch to change between AM/FM bands
17. **AS**: Touch to automatically store stations
18. Touch this area to return to the MAIN MENU

### Switch to Radio Tuner source

Press the **TUNER** button (10) on the front panel or the SRC button on the remote control (8) to switch to the TUNER source.

### Select FM/AM Band

Touch the **BAND** button (16) on the screen, or press the **TUNER** button (10) on the unit or the **BAND** button on the remote control (20) to change between the following bands: FM1, FM2, FM3, AM1, and AM2.

### Auto Tuning

Press and hold the ▶▶ button (19) on remote control or screen, or the ▶ button on the joystick (9) to seek the next available radio station by increasing the tuning frequency. Press the button again to stop searching.

Press and hold the ◀◀ button (17) on the remote control or screen, or the ◀ button on the joystick (8) to seek the next available radio station by decreasing the tuning frequency. Press the button again to stop searching.

### Manual Tuning

Press the ▶▶ or ◀◀ buttons (14, 22) on the remote control or screen, or the ▲ or ▼ buttons (6, 7) on the joystick to increase or decrease the tuning frequency one step.

Press and hold the buttons to continuously tune until you release them.

### Using Preset Stations

Six numbered preset buttons store and recall stations for each band. All six stored stations (P1-P6) for the current band appear on the screen.

#### Storing a Station

1. Select a band (if needed), then select a station.
2. Touch and hold an on-screen preset button (6) for three seconds. The preset number appears at the top of the screen.

#### Recalling a Station

1. Select a band (if needed).
2. Touch an on-screen preset button (6) to select the corresponding stored station.



### Auto Store (AS)

#### Automatic Storing of Preset Stations

To select six strong stations and store them in the current band:

1. Select a band (if needed).
2. Touch **AS** (17) for 2 seconds to activate the Auto Store function.

The new stations replace stations already stored in that band.

### Local Radio Station Seeking (LOC)

When the Local function is on, only radio stations with a strong radio signal are played. To activate the Local function in AM/FM tuner mode, press and hold the **AUDIO/LOC** button (2) on the front panel while the yellow volume bar IS NOT visible. Press **AUDIO/LOC** again to turn Local off. When the Local function is active, "LOC" appears on the screen and a green indicator is illuminated.

## DVD PLAYER OPERATION

*NOTE: When properly installed, DVD video cannot be displayed on the main TFT screen unless the parking brake is applied. If you attempt to play a DVD while the vehicle is moving, the TFT screen displays "PARKING" with a blue background. Rear video screens, if applicable, will operate normally.*

### Opening/Closing the TFT Video Screen

#### Opening the TFT Screen

To open the TFT video screen, press the **OPEN** (2) button. The unit beeps and then opens.

#### Closing the TFT Screen

Press the **OPEN** (12) button again to close the TFT screen. If the screen is in the "IN" position, it moves out before closing.

### Insert/Eject Disc

Upon inserting a DVD disc, DVD mode is entered disc play begins. If the TFT screen is closed, the DVD indicator appears lit on the LCD screen.

**NOTE: If Parental Lock (Rating) is activated and the disc inserted is not authorized, the 4-digit code must be entered and/or the disc must be authorized (see "RATING (Parental Lock) Menu" on page 19).**

You cannot insert a disc if there is already a disc in the unit or if the power is off.

**NOTE: CD-R/RW, DVD-R/RW, DVD+R/RWs will not play unless the recording session is closed.**

### Ejecting a Disc

Press the **▲** button (22) on the unit or remote control (25) to eject the disc. The unit automatically reverts to Tuner mode. You may eject a disc with the power off and the unit remains off after the disc is ejected.

### Reset the Loading Mechanism

If the disc loads abnormally or an abnormal core mechanism operation occurs, press and hold the **▲** button (22) on the unit or remote control (25) to reset the loading mechanism. Normal operation resumes.

### Accessing DVD Mode

To switch to DVD mode when a disc is already inserted, press the **DVD** button (18) on the front panel, or press the **SRC** button (8) on the remote control until DVD appears at the bottom of the screen.

### Using the Touch-Screen Controls

The touch key areas for DVD playback are outlined below.

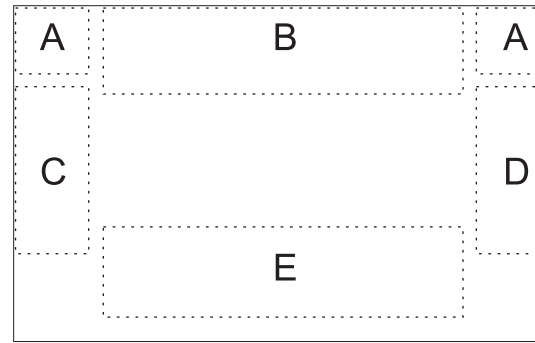

A – Return to MAIN MENU

B – DISP key: Displays playing information

C – Select previous chapter

D – Select next chapter

E – Display the following on-screen controls: Menu, ►/II, ■, ◀◀, ▶▶, ◀◀, ▶▶

### Controlling Playback

#### Stopping Playback

Touch the stop button (■) on the screen or press the ■ / **BAND** button (20) on the remote control to stop DVD play.

#### Pausing Playback

Touch the play/pause button (►/II) on the screen or press the ►/II button on the remote control (18) to suspend or resume disc play.

#### Slow Motion Playback

Press the ► button (22) on the remote control or the ▼ button (7) on the joystick to play the current title in slow motion at 1/2, 1/4, 1/6 or 1/7, the normal speed. Press ►/II (18) to resume normal play. Continue pressing the ► or ▼ button to slow reverse.

#### Repeat Playback

Press the **REPT** button (7) on the remote control to alter repeat mode according to the following:

- DVD: Repeat Title, Repeat Chapter, Repeat Off
- VCD (PBC Off): Repeat Single, Repeat Off
- MP3: Repeat Single, Repeat Folder, Repeat Off

**NOTE: For VCD play, the repeat function is not available if PBC is on.**

### Sectional Repeat Function (A-B)

Use the A-B function to define a specific area of a disc to repeat.

- Press the **REPT A-B** button (6) on the remote control to set the start point (A) of the repeated section.
- Press the **REPT A-B** button again once you reach the desired end point (B) of the repeated section. The selected portion of the DVD will now repeat continuously.
- Press the **REPT A-B** button again to cancel the A-B section setting and stop repeat play.

### Random Playback

With a DVD, VCD, or CD playing, press the **RDM** button (33) on the remote control to activate random playback and play all chapters/tracks in random order. "On" appears on the screen.

Press the ►► button (19) on the remote control or the ► button on the joystick (9) to play the next random track.

Press the **RDM** button again to turn random play off.

**NOTE: When a VCD is playing with PBC turned "On", activating random playback automatically turns PBC off.**

### Accessing the DVD Menu

Press the **MENU** button (1) on the remote control to recall the main DVD menu. Use the directional (arrow) buttons (◀, ▶, ▲ & ▼) on the joystick (16, 17, 18, 19) to select a title from the menu.

Press the **TITLE** button (2) on the remote control to select a different title for playback.

Press the ►/II button (18) on the remote control or the **ENTER** (joystick) button (20) to confirm your selection and begin playback.

### Moving Through Chapters

Press the ►► button (19) on the remote control or the ► button on the joystick (17) to advance to the next chapter on the DVD.

Press the ◀◀ button (17) on the remote control or the ◀ button on the joystick (16) to move to the previous chapter.



### Fast Forward/Fast Reverse

Press the ►► button (14) on the remote control or the ▲ button (6) on the joystick to fast forward. Keep pressing and releasing the button to increase the rate from “2X” to “4X”, “8X”, and “20X”. Continue pressing the ►► or ▲ button to fast reverse.

### Scanning

Press the **SCN** button (?) on the remote control to play the first ten seconds of each chapter. Press **SCN** again to stop the scan function and play the current chapter.

### Selecting 2-Channel and 6-Channel Audio Playback

#### 2-Channel Audio (Down Mix) Support for CD, SD Card and DVD

Linear pulse code modulation (LPCM) and pulse code modulation (PCM) support is available for CD, SD Card and DVD discs when 2-channel audio is selected.

#### 6-Channel Audio Support for CD, SD Card and DVD

Surround I is available for decoding analog or digital 2-channel down mixed sources. Surround II is available for decoding digital bit-stream sources.

**NOTE: 2-Channel audio support is available for AM / FM tuner, TV tuner and Auxiliary input only.**

Table 8: Speaker Output Options

Speaker Setup	Front Spkr	Rear Spkr	Center Spkr	Sub-Woofer
2CH mode	X	X		
Play 2CH audio in 6CH mode with Surround "Off"	X			
Play 2-channel (down mix) audio in 6-channel mode with Surround I "ON"	X	X	X	X
Play 6-channel audio in 6-channel mode with Surround II "ON"	X	X	X	X

### Goto Search

During DVD or VCD playback, perform the following steps to use the GOTO feature to access a specific location on a disc:

1. Press the GOTO button (21) on remote control to enter “GO TO” mode.
- C : 2/16 – “2 / 16” indicates that the second of 16 titles

Press the ►► or ► buttons (14, 22) on the remote control or the ◀ or ► buttons (8, 9) on the joystick to select a category (highlighted in blue).

- For DVD mode, you can choose Time or Title/Chapter search.

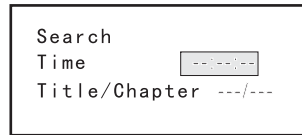

#### DVD Search

**Time** – Go to specific time in current title  
**Title/Chapter** – Go to specific time in a chapter

- For VCD mode, press the **GOTO** button to choose between Track Search, Disc Search and Exit.



#### VCD Track Search

**Time** – Go to specific time in the current track  
**Track** – Go to specific track

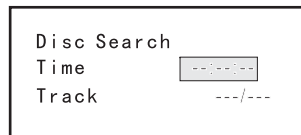

#### VCD Disc Search

**Time** – Go to specific time on disc  
**Track** – Go to specific track

2. Enter a time into the field using the numeric keypad (29) on the remote control.
3. Press the ►/|| button (18) on the remote control or the **ENTER** (joystick) button (5) to go to the specified location on the disc.
4. Press the **GOTO** button again to exit.

### Direct Chapter / Track Selection

During DVD, VCD and CD playback, you can use the numeric keypad on the remote control (29) to access a track directly.

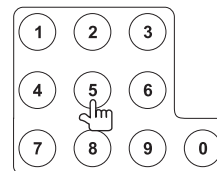

### Viewing an Alternate Picture Angle (DVD Only)

Some DVDs contain scenes that have been shot simultaneously from different angles. For discs recorded with multiple angles, press the **ANGLE** button (13) on the remote control to toggle available angles of the on-screen image.

on the DVD is currently playing.

### Zooming

Press the **ZOOM** button (23) on the remote control to enlarge and pan through the video image using the following options: “Q1”, “Q2”, “Q3”, and “OFF”.

### Multi-Language Discs (DVD Only)

#### Changing Audio Language

If you are watching a disc recorded in multiple languages, press the **AUDIO** button (5) on the remote control to choose a language.

#### Changing Subtitle Language

If you are watching a disc recorded in multiple languages with subtitles, press the **SUBTITLE** button (9) on the remote control to choose the language in which you would like the subtitles to appear.

**NOTE: During VCD playback, press the AUDIO button (5) on the remote control to choose between Left Channel, Right Channel, and Stereo.**

### PBC (Play back Control) (VCD Only)

For VCDs with play back functionality, play back control (PBC) provides additional controls for VCD playback. Press the **MENU** button (1) on the remote control to toggle the PBC function “On”/“Off”. Once PBC is on, playback starts from track one of the play list.

**NOTE: When PBC is activated, fast forward, slow playback, and previous/next track are available. Repeat and direct track selection are not available.**

When PBC is activated, selecting random, scan, or search playback automatically deactivates PBC.

### Playback Information

During DVD and VCD playback, press the **DISP** button (10) on the remote control to display playback information on the screen, including the media playing and current playback time.

#### DVD Playback Information

The following information is displayed at the bottom of the screen during DVD playback:

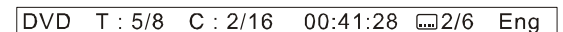

- T : 5/8 – “5 / 8” indicates the fifth of 8 titles on the DVD is currently playing.

- 00:41:28 – “00:41:28” indicates the playback time of the current title.
- 2 / 6 Eng – The language display information indicates the second language out of 6 (English) is currently being used.

The following information appears at the *bottom* of the screen during DVD playback:

Front: DVD    Rear: AUXIN    SURR II    DSP

- Front: DVD is the current playback source for the front zone.
  - Rear: AUX IN is the current playback source for the rear zone.
- “Surround II” is the selected playback audio encoding process.  
 “DSP” indicates Digital Signal Processing.

#### VCD Playback Information

The following information is displayed on the screen during VCD playback:

VCD2.0    T: 6/18    00:02:18

- VCD2.0 – Format of current disc.
- T: 6/18 – “6/18” indicates the sixth of 18 tracks on the VCD is currently playing.
- 00:02:18 – “00:02:18” indicates the playback time of the current track.

The following information appears on the screen during VCD playback in 6-Channel mode:

Front: DVD    Rear: AUXIN    MPEG    MOVIE

- Front: DVD – “DVD” is the current playing source for the front zone.
  - Rear: AUX IN – “AUX IN” is the current playing source for the rear zone.
- “MPEG” is the decoding method in use.  
 “Movie” indicates that movie effects are being applied to the audio sound track from the VCD.

The following information appears on the screen during VCD playback in 2-Channel mode:

FRONT: DVD    REAR: AUX IN    EQ: FLAT    LOUD: Level 1

- Front: DVD – “DVD” is the current playing source for the front zone.

- Rear: AUX IN – “AUX IN” is the current playing source for the rear zone.
- EQ:FLAT – The equalizer setting is FLAT.
- Loud: Level 1 – The Loud option is set to Level 1 loudness.

### General Disc Information

Table 9: Disc Properties

Symbol	12cm Disc Properties	Max Play Time
	Single side single layer (DVD-5) Single side double layer (DVD-9) Double side single layer (DVD-10) Double side double layer (DVD-18)	(MPEG 2 Method) 133 minutes 242 minutes 266 minutes 484 minutes
	Single side single layer (VCD)	(MPEG 1 Method) 74 minutes
	Single side single layer	74 minutes

Table 10: Disc Symbols

Symbol	Meaning
	Number of voice languages recorded. The number inside the icon indicates the number languages on the disc (maximum of 8).
	Number of subtitle languages available on the disc (maximum of 32).
	Number of angles provided (maximum of 9).
	Aspect ratios available. “LB” stands for Letter Box and “PS” stands for Pan/Scan. In the example on the left, the 16:9 video can be converted to Letter Box video.
	Indicates the region code where the disc can be played. <ul style="list-style-type: none"> <li>• Region 1: USA, Canada, East Pacific Ocean Islands</li> <li>• Region 2: Japan, Western Europe, Northern Europe, Egypt, South Africa, Middle East</li> <li>• Region 3: Taiwan, Hong Kong, South Korea, Thailand, Indonesia, South-East Asia</li> <li>• Region 4: Australia, New Zealand, Middle and South America, South Pacific Ocean Islands/Oceania</li> <li>• Region 5: Russia, Mongolia, India, Middle Asia, Eastern Europe, North Korea, North Africa, North-West Asia</li> <li>• Region 6: Mainland China</li> <li>• ALL: All regions</li> </ul>

## DVD SETUP MENU

In “DVD Setup” mode, “LANGUAGE”, “VIDEO”, “AUDIO”, “SURR SETUP”, “SURROUND FX”, and “RATING” (parental lock) are available for setup. This operation can be performed using the remote control or joystick controls.

### Accessing the DVD Setup Screen

Setup can be performed by pressing the dedicated button on the remote control or by pressing the **MENU/SRC** button (11) on the front panel.

For system settings, press the **DVD SETUP** button (30) on the remote control or touch “SETUP” on the screen to enter the “SETUP” menu. “SYS SETUP” is highlighted in green.

To access the “DVD SETUP” Menu, press the ▼ button (7) on the remote control to choose the “DVD SETUP” option, then press the ►/|| button (18), or just touch “DVD SETUP” on the screen. “LANGUAGE” is highlighted in green.

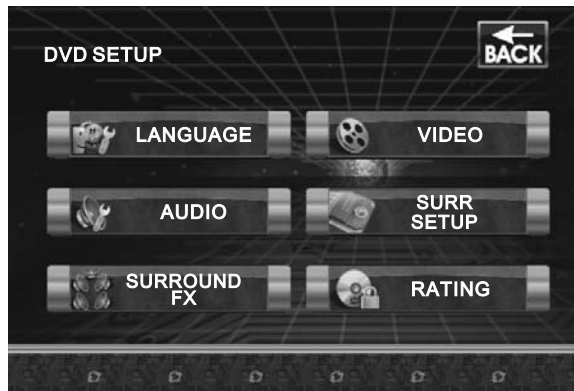

**NOTE:** Once the DVD setup is complete, the settings are memorized. To return to the factory default settings, press the **RESET** button (25) on the front panel.

### Accessing a Menu

To access a menu (LANGUAGE, VIDEO, AUDIO, SURR SETUP, SURROUND FX, or RATING), press the direction buttons on the joystick (6, 7, 8, 9) or remote control (14, 17, 18, 19, 22) to highlight the desired menu in green. You can also touch the on-screen menu selection to access that menu.

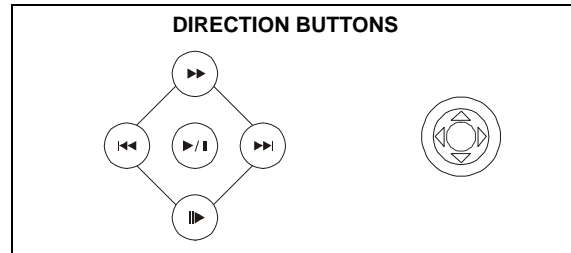

### Selecting a Feature for Adjustment

Once inside a menu, press the ►► or ► buttons (14, 22) on the remote control or the ▲ or ▼ buttons (6, 7) on the joystick to select the feature to be adjusted.

### Adjusting a Feature

1. Enter the option field for the feature you want to adjust by pressing the ►/|| button (18) on the remote or by pressing the **ENTER** (joystick) button (5) on the unit. A submenu appears in a second row with the selected option highlighted in light blue.
2. Select a new value by pressing the ►► or ► buttons (14, 22) on the remote control or the ▲ or ▼ buttons (6, 7) on the joystick.
3. Confirm your selection by pressing the ►, ◀◀, or ►► buttons (14, 17, 19) on the remote control, or the ◀ or ► button (8, 9) on the joystick. The new value is highlighted in light blue and setup is complete.

## LANGUAGE Menu

If a DVD supports more than 1 Subtitle or Audio language, all the languages are available for selection during playback. If the selected language is not supported by the DVD, then the default language is used. During playback, press the **SUBTITLE** (9) or **AUDIO** (5) button on the remote control to change the language directly. This will not effect the DVD menu settings.

Table 11: LANGUAGE Menu Features

Setting	Options	Function
Subtitle	English	Select the default language in which you would like subtitles (if applicable) to be displayed.
	Auto	
	Off	
Audio	English	Select the default language in which you would like audio (when optional) to be played.

Table 11: LANGUAGE Menu Features

Setting	Options	Function
DVD Menu	English	Select the default language in which you would like the DVD menu (if applicable) to be displayed.
BACK		Return to previous menu.

## VIDEO Menu

Table 12: VIDEO Menu Features

Setting	Options	Function
TV Shape (Aspect Ratio)	4:3 PS	With 16:9 display, the left and right sides are cut off.
	4:3 LB	With 16:9 display, the top and bottom are cut off.
	16:9	Image is presented in wide view with a 16:9 aspect ratio.
Angle Mark	On	Angle indicator (if applicable) is shown.
	Off	Angle indicator is not shown.
View Mode	Fill	
	Original	
	H Fit	
	W Fit	
	Fit to Scrn	
BACK		Return to previous menu.

**NOTE:** For standard discs not formatted for “widescreen”, use of the 16:9 aspect ratio will result in image distortion.

## AUDIO Menu

The VM9020TS has a built-in Pink Noise generator to help set the relative speaker levels for multi-channel audio playback.

**Table 13: AUDIO Menu Features**

Setting	Options	Function
Pink Noise	Off	Stop output of pink noise
	Left	Left channel pink noise
	Center	Center channel pink noise
	Right	Right channel pink noise
	Left Surr	Left surround channel pink noise
	Right Surr	Right surround channel pink noise
	Subwoofer	Subwoofer pink noise
DRC	Off	Employ the Dynamic Range Control for better playback for low volumes.
	On	
CNTR CTRL	5ms	Adjust the time difference between the center and front speakers to create a time delay between 1 and 5 milliseconds, producing a more accurate audio effect.
	4ms	
	3ms	
	2ms	
	1ms	
	0ms	
REAR CTRL	15ms	Adjust the time difference between the rear and front speakers to create a time delay between 3 and 15 milliseconds, producing a more accurate audio effect.
	12ms	
	9ms	
	6ms	
	3ms	
	0ms	
Down Sampling	Off	Normal Output
	on	Audio signal output at 48kHz
BACK		Return to previous menu.

**NOTE: When Down Sampling is ON, the audio output signal will be converted to 48kHz. When Down Sampling is OFF, the original sampling frequency is preserved.**

## SURR SETUP Menu

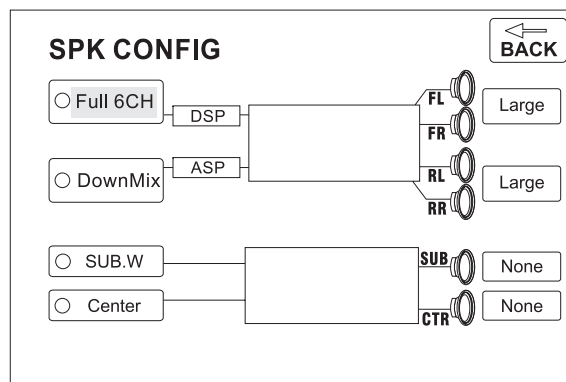

To change speaker settings for 2-channel mode, use the ►► or ► buttons (14, 22) on the remote control or the ▲ or ▼ buttons (6, 7) on the joystick to select "DownMix". To change speaker settings for 6-channel mode, select "Full 6CH". After selecting 2 or 6-channel mode, use the ►► button (19) on remote control or the ► button on the joystick (7) to move to the speaker settings on the right.

### Speaker Selection

Selecting LARGE for the multi-channel speaker option will give a full range output. Selecting SMALL for the multi-channel speaker option will activate a high pass filter whose crossover is dependent upon the sub-woofer low pass filter frequency. For example, if the subwoofer low pass filter is set to 80Hz, then the high pass SMALL speaker crossover will be set to 90Hz.

Low pass	High pass
80Hz	90Hz
120Hz	135Hz
160Hz	180Hz

Refer to Table 14 when selecting speaker options for each mode.

**Table 14: SURR SETUP Menu Features**

Setting	Options	Function
FL (Front Left) / FR (Front Right)	Large	Use when front speakers have good bass output.
	Small	Use when speakers do not have good bass output.

**Table 14: SURR SETUP Menu Features**

Setting	Options	Function
LR (Left Rear) / RR (Right Rear)	Large	Use when rear speakers have good bass output.
	Small	Use when rear speakers do not have good bass output.
	None	Use when rear speakers are not present.
SUB (Subwoofer)	Present	Use when subwoofer is present.
	None	Use when subwoofer is not present.
CTR (Center)	Large	Use when center speaker has good bass output.
	Small	Use when center speaker does not have good bass output.
	None	Use when center speaker is not present.
BACK		Return to previous menu.

## SURROUND FX

**Table 15: SURROUND FX Menu Features**

Setting	Options	Function
Decode Mode	Off	Play original audio format.
	Surround I	Use Surround I decoding method.
	Surround I Matrix	Play mono output with surround effect.
	Surround I Movie	Enhance movie surround effects.
	Surround I Music	Play surround music effects.
Panorama (Only available when Surround I Music Mode is activated.)	On	Extend the video from the front to the rear to achieve a better surround effect.
	Off	Panorama is turned off.
Dimension Ctrl	0-6	Shift audio output between front and rear speakers.
Center Width Ctrl	0-6	Shift audio output between front and center channel speakers.
BACK		Return to previous menu.

**NOTE: Surround I is recommended when the playback source is LPCM (Linear Pulse Code Modulation) or 2-channel down mixed digital bit-stream.**

**NOTE: When Surround I Music mode is selected, Dimension Control and Center Width are available for fine tuning to achieve a more realistic surround sound processing.**

**RATING (Parental Lock) Menu**

The DVD system has a built-in parental lock feature to prevent unauthorized persons from viewing restricted disc content. By default, the rating system is unlocked. Once setup, the parental lock is released only by entering the correct password. Once the password is entered, rating is available for setup.

**Table 16: RATING Menu Features**

Setting	Options	Function
Password	----	Enter a 4-digit password to activate the "Rating" feature.
Rating	1. Kid Safe	Select the appropriate rating level for the intended audience.  You may override higher ratings by using your password.
	2. G	
	3. PG	
	4. PG-13	
	5. PG-R	
	6. R	
	7. NC-17	
	8. Adult	
Load Factory	Reset	Select "Reset" to restore the factory default settings for the <i>Rating system only</i> .
BACK		Return to previous menu.

To reset the password, access the "RATING" menu and enter the current password. Once the correct password is entered, you can access the "Password" field and enter a new one.

**NOTE: Record the password and keep it in a safe place for future reference. The rating for each disc is marked on the disc, disc packing, or documentation. If the rating is not available on the disc, the parental lock feature is unavailable. Some discs restrict only portions of the disc and the appropriate content will play. For details, please refer to the disc description.**

## CD/MP3/WMA OPERATION

Instructions for Insert/Eject, Play/Pause, Stopping Playback, Track Selection, Fast Forward/Fast Reverse, Scan, and Random Play are the same for DVD, CD and MP3 operation. Please see the DVD Player Operation section for information about these topics.

**NOTE: CD-R and CD-RW will not play unless the recording session is closed.**

The file naming formats listed below are compatible with this unit:

- ISO 9660 – file name: 12 characters, file extension: 3 characters
- ISO 9660 – file name: 31 characters, file extension: 3 characters
- Joliet – 64 characters

If the file or folder name does not conform to ISO 9660 file system standards, it may not be displayed or played back correctly.

### CD Player User Interface

The on-screen indicators and touch key areas for CD playback are outlined below.

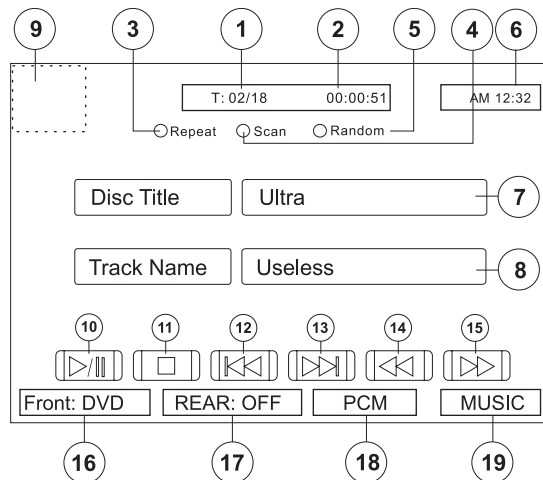

1. Current track and total number of tracks on disc
2. Elapsed playing time
3. Touch to activate/deactivate Repeat play mode
4. Touch to activate/deactivate Scan mode
5. Touch to activate/deactivate Random mode

6. Current time
7. Disc Title
8. Track Title
9. Touch to return to MAIN MENU
10. ►/||: Touch to play/pause disc playback
11. ■: Touch to stop disc playback
12. ◀◀: Touch to move to previous track
13. ▶▶: Touch to move to next track
14. ◀◀: Touch to rewind current track
15. ▶▶: Touch to fast forward current track
16. Front Zone Playing Mode
17. Rear Zone Playing Mode
18. Encoding method of media being played.
19. "Surround Music" effect selected.

### MP3/WMA Discs

This player allows you to playback MP3 files recorded on CD-ROM, CD-R, and CD-RW. For CD-RW discs, please make sure it is formatted using the full method and not the quick method to prevent illegal disc operation.

Use the following settings when compressing audio data for your MP3 disc:

- Transfer Bit Rate: 320kbps
- Sampling Frequency: 48kHz

When recording MP3 up to the maximum disc capacity, disable additional writing. For recording on an empty disc up to maximum disc capacity, use the "Disc at once" setting.

### Playing MP3/WMA Files

After inserting a MP3/WMA disc, files will play in the sequence of the "Root" directory.

Use the numeric keypad (29) on the remote control to access files directly.

### Selecting a Playback Mode

1. Press the ■/BAND button (20) on the remote control to stop disc play.
2. Press the ►▶ button (19) on the remote control or the ► button on the joystick (9) to enter playback mode (PLAY MOD).
3. Press the ►||, ◀◀, or ▶▶ buttons (18, 17, 19) on the remote control, or the ◀ or ▶ button (8, 9) on the joystick to choose from the following playback options:

Table 17: MP3/WMA Playback Modes

Play Mode	Playback Details
Disc Normal	Playback all files on the disc and stop at the end.
Disc Repeat	Repeat playback of all files on the disc.
Random	Randomly play all files and stop at the end.
Single Track	Play a specific file and stop.
Repeat Track	Repeat playback of a specific file.
Folder Normal	Play all files in a folder and stop at the end.
Folder Repeat	Repeat playback of all files in a folder/directory.

4. Press the ►▶ button (14) on the remote control to confirm the playback mode then press the ►|| button (18) to begin playback.

## SD CARD READER OPERATION

### Accessing SD Card Mode

To switch to SD card mode, press the **SD** button (19) on the front panel.

### Using the Touch-Screen Controls

The touch keys for SD card playback are described below.



- : Play/Pause playback
- : Stop playback
- PAGE -: View previous page
- PAGE +: View next page
- DIR -: View previous directory
- DIR +: View next directory

### Controlling Playback

#### Stopping Playback

Touch the stop button () on the screen or press the **BAND** button (20) on the remote control to stop playback.

#### Pausing Playback

Touch the play/pause button () on the screen, press the button on the remote control (18), or press the joystick button (5) on the front panel to suspend or resume playback.

#### Repeat Playback

Press the **REPT** button (7) on the remote control or touch "Repeat" on the screen to alter repeat mode according to the following: Repeat Single, Repeat Folder, Repeat Off

#### Random Playback

Press the **RDM** button (33) on the remote control or touch "Random" on the screen to activate random playback and play all tracks in random order.

### Moving Through Chapters

Press the button (19) on the remote control or the button on the joystick (17) to advance to the next chapter.

Press the button (17) on the remote control or the button on the joystick (16) to move to the previous chapter.

### Change Directory

Touch the ( [DIR+] / [DIR-] ) key on the screen to navigate through the Directories / Folders

### Previous/Next Page

Touch the ( [PAGE+] / [PAGE-] ) key on the screen to navigate through Pages / Files.

### Direct Chapter / Track Selection

During DVD, VCD and CD playback, you can use the numeric keypad on the remote control (29) to access a track directly.

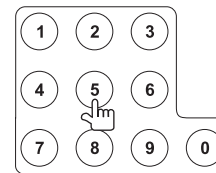

---

**NOTE: Media (SD Card / CD-R / DVD) with a ROOT directory containing only music, movie or JPEG files may cause the RANDOM / REPEAT function to work incorrectly. To ensure the proper playback of music, movie, and JPEG files, place all media files inside folders on the data storage media.**

---

## TV TUNER OPERATION

### Accessing TV Mode

To switch to TV mode, press the **TV** button (16) on the front panel or press the **SRC** button (8) on the remote control until TV appears at the bottom of the screen.

---

**NOTE:** Touch the top left corner to access the **MAIN MENU Multi-ZONE SETUP** menu and the top right corner to access the **Multi-ZONE** menu (rear zone setup).

---

### Auto Tuning

Press the **▶▶** button (19) on remote control, or the **▶** button on the joystick (9) to seek the next available TV station by increasing the tuning frequency.

Press the **◀◀** button (17) on the remote control, or the **◀** button on the joystick (8) to seek the next available TV station by decreasing the tuning frequency.

Press the **■/BAND**, **◀◀**, **▶▶**, **◀** or **▶** button to stop searching.

Once a TV station is searched, the auto seeking stops and the TV station is played. If no station is searched, the tuning stops at the first channel after performing a round search.

### Manual Tuning

Press and hold the **◀** or **▶** buttons (8, 9) on the joystick to increase or decrease the TV frequency one step.

### Storing Stations (AS)

#### Automatic Preset Memory

To select the strong stations in the current TV frequency range, press and hold the joystick button (5) to activate the Auto Store function. The new stations replace stations already stored. Press the joystick button again or press the **■/BAND** button (20) on the remote control to stop searching.

#### Using Preset Scan

To scan stored stations:

1. Press the joystick button (5) to scan all stored TV stations. The unit pauses for 10 seconds at each station.
2. Press the joystick button again or press the **■/BAND** button (20) on the remote control to stop scanning and play the current station.

#### Selecting a TV Station

To browse through stored stations:

- Press the **◀◀** button (15) on the remote control or the **▲** button (6) on the joystick to tune to the previous stored station.

- Press the **▶▶** button (22) on remote control or the **▼** button (7) on the joystick to tune to the next stored station.

### Direct Channel Selection

Use the numeric keypad on the remote control (29) to enter a specific TV frequency.

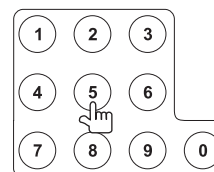

### Display Current Channel

Press the **DISP** button (10) on the remote control to display information regarding the current TV station.



## TROUBLESHOOTING

Table 18: Troubleshooting

Problem	Cause	Corrective Action
<b>GENERAL</b>		
Unit will not power on	Radio Fuse blown	Install new fuse with correct rating
	Car battery fuse blown	Install new fuse with correct rating
	Illegal operation	Press the RESET button located in the bottom right corner of the front panel
Remote control does not function	Battery depleted	Replace battery with new one
	Battery installed incorrectly	Remove battery and install correctly
No/low audio output	Improper audio output connection	Check wiring and correct
	Volume set too low	Increase volume level
	Improper "MUTE" connection	Review wiring diagram and check "MUTE" connection
	Speakers damaged	Replace speakers
	Heavily biased volume balance	Adjust the channel balance to the center position
	Speaker wiring is in contact with metal part of car	Insulate all speaker wiring connections
Poor sound quality or distortion	Pirated disc is in use	Use original copy
	Speaker power rating not compatible with unit	Connect proper speakers
	Speaker is shorted	Check speaker contact
Tel-Mute malfunction	"MUTE" wire is grounded	Check that "MUTE" connection is not grounded and that it's properly insulated
Unit resets itself when engine is off	Incorrect connection between ACC and positive battery wire	Check wiring and correct
<b>TFT MONITOR</b>		
Monitor does not open automatically	TFT Auto Open is turned off	Turn TFT Auto Open on
No image	Incorrect connection to parking brake wire	Check wiring and correct
	PRK SW is activated and parking brake is not engaged	Stop vehicle in safe place and apply parking brake
Flashing image or interference appears on screen	DVD is not compatible with current TV system settings	Change setup to accommodate disc
	Improper video signal connections	Check wiring and correct
Prolonged image or improper height/width ratio display	Improper aspect ratio setup	Use correct aspect ratio setting
Monitor stops at incorrect position	Moving path is blocked	Press OPEN key to restart monitor movement
<b>TUNER</b>		
Weak station searching	Auto antenna is not fully extended	Connect the auto antenna control cable properly
	Auto antenna not properly connected	Connect the auto antenna control cable properly
	LOCAL function is activated	Turn LOCAL function off
Cannot insert disc	Disc already inside unit	Eject current disc and insert new one
Disc does not play back	Disc is warped or scratched	Use disc in good condition
	Disc is dirty or wet	Clean disc with soft cloth
	Laser pickup is dirty	Clean laser pickup with cleaning disc
	Incompatible disc is used	Use compatible disc
	Disc rating exceeds Parental Lock rating limit	Change Parental Lock settings to lower restriction
	Disc region code is not compatible with unit	Use disc with proper region code
	Disc is inserted upside down	Insert disc with label side up

**Table 18: Troubleshooting**

Problem	Cause	Corrective Action
Image blurred, distorted, or dark	Disc is illegally copied	Use original disc
PBC cannot be used during VCD playback	PCB is not available on the disc	
No repeat or searching while playing VCD	PCB is on	Turn PCB off
<b>MP3</b>		
Interruption occurred during playback	Disc is dirty or scratched	Clean disc or replace
	File is damaged/bad recording	Recreate disc with good files
Incorrect playback message displayed	Message is longer than LCD can display	

## Error Messages

**Table 19: Error Messages**

Message Displayed	Cause	Corrective Action
Loading	Disc is being read	
No Disc	Disc is dirty	Clean disc with soft cloth
	Disc is upside down	Insert disc with label side up
	Disc not present in loading compartment	Insert disc
Bad Disc	Disc is dirty	Clean disc with soft cloth
	Disc is upside down	Insert disc with label side up
Unknown disc	Disc format is not compatible with this unit	
Region Error	DVD is not compatible with region code of unit	
Error	illegal mechanism operation	Press EJECT key for 5 seconds to reset loading mechanism

## Care and Maintenance

- Use only a clean silicone cloth and neutral detergent to clean the front panel or monitor. A rough cloth and non-neutral detergent (such as alcohol) may result in scratching or discoloration.
- Do not get water or cleaning fluids on the unit.
- If the temperature inside the player gets too hot, a protective circuit automatically stops play of the disc. If this occurs, allow the unit to cool before operating the player again.
- Never insert anything other than a 5" (12 cm) compact disc into the player as the mechanism can be damaged by foreign objects.
- Do not attempt to use a 3" (8 cm) CD-Single disc in this unit, either with or without an adaptor, as damage to the player and/or disc may occur. Such damage is not covered by the Warranty on this product.
- The CD player may not operate properly in extreme hot or cold. If such conditions occur, allow the interior of the vehicle to reach a normal temperature before using player.
- When the vehicle warms up during cold weather or under damp conditions, condensation may appear on the LCD panel. Should this occur, the screen will not operate properly until the moisture has evaporated.
- We suggest you use a cleaning disc in this unit more frequently than in the unit in your home due to the environmental conditions of the vehicle.

## SPECIFICATIONS



### CEA Power Ratings

#### Main Amplifier

Power Output: 18 watts RMS X 4 channels into 4-ohms @ < 1% THD+N

Signal to Noise Ratio: 70dBA below reference. (Reference: 1 watt, 4-ohms)

Dynamic Power: 88 watts into 4-ohms, all channels driven  
Frequency Response: 20Hz to 20kHz, -3dB. Aux input used as source reference

Reference Supply Voltage: 14.4VDC

#### Center Amplifier

Power Output: 22 watts RMS X 1 channels into 4-ohms @ < 1% THD+N

Signal to Noise Ratio: 70dBA below reference. (Reference: 1 watt, 4-ohms)

Dynamic Power: 25 watts into 4-ohms, all channels driven  
Frequency Response: 20Hz to 20kHz, -3dB

Reference Supply Voltage: 14.4VDC

#### DVD/CD Player

Compatible formats: DVD-R, DVD-RW, DVD+R, DVD+RW, CD-R, CD-RW, CD-DA, MP3, WMA, HDCD, SVCD, VCD, MPEG, JPEG, MP3/WMA files burned onto a DVD+R/W or DVD-R/W and Kodak Picture CD

Signal to Noise Ratio: 95dBA

Dynamic Range: >95dB

Frequency Response: 20Hz to 20kHz, -3dB

Channel Separation: > 60dB @ 1kHz

D/A Converter(s): 6-channel high performance 24-bit, 192kHz, multi-bit Sigma Delta modulation. DAC supports sample rates from 8~192kHz.

Electronic Skip Protection (ESP): 16Mbit high-speed flash memory

DVD: 2-3 sec, CD-DA: 10 sec, MP3: 100 sec, WMA: 200 sec (ESP time is approximate)

#### Video

Format: NTSC, PAL (auto-detection)

Output: 1Vp-p (75-ohm), buffered

Input: 1Vp-p (75-ohm)

#### FM Tuner

Tuning Range: 87.5MHz - 107.9MHz

Mono Sensitivity (-30dB): 9dBf

Quieting Sensitivity (-50dB): 15dBf

Alternate Channel Selectivity: 70dB

Signal to Noise Ratio @ 1kHz: 58dB

Image Rejection: 80dB

Stereo Separation @ 1kHz: 30dB

Frequency Response: 30Hz - 15kHz, -3dB

#### AM Tuner

Tuning Range: 530kHz - 1710kHz

Sensitivity (-20dB): 30uV

Signal to Noise Ratio @ 1kHz: 50dB

Image Rejection: 60dB

Frequency Response: 50Hz - 2kHz, -3dB

#### Monitor

Screen Size: 6.5" (Measured diagonally), 16:9 Widescreen

- 6.1" (155mm) W X 3.51" (89.2mm) H

Screen Type: TFT Liquid Crystal Display (LCD), active matrix

Brightness: 400 cd/m<sup>2</sup>

Contrast Ratio: 350

Response Time: 15mS rise time, 25mS fall time

Resolution:

- 280, 800 sub pixels, 1200 (W) X 234 (H)

Viewing angle:

- 65 degrees left or right
- 40 degrees up
- 65 degrees down

Anti-glare screen

#### General

Auxiliary Input impedance: 10k

Power Supply: 11 to 16VDC, negative ground

Fuse: 10-amp, mini ATM type

Double-DIN chassis dimensions: 7" X 7" X 4" (178mm x 178mm x 100mm)

\*\* Specifications subject to change without notice.



## 12-MONTH LIMITED WARRANTY

AUDIOVOX CORPORATION (the Company) warrants to the original retail purchaser of this product that should this product or any part thereof, under normal use and conditions, be proven defective in material or workmanship within 12 months from the date of original purchase, such defect(s) will be repaired or replaced with new or reconditioned product (at the Company's option) without charge for parts and repair labor. To obtain repair or replacement within the terms of this Warranty, please contact Jensen at the telephone number provided below.

This Warranty does not extend to the elimination of car static or motor noise, to correction of antenna problems, to costs incurred for installation, removal, or reinstallation of the product, or damage to tapes, compact discs, accessories or vehicle electrical systems. This Warranty does not apply to any product or part thereof which, in the opinion of the Company, has suffered or been damaged through alteration, improper installation, mishandling, misuse, neglect, accident, or by removal or defacement of the factory serial number/bar code label(s) or markings. THE EXTENT OF THE COMPANY'S LIABILITY UNDER THIS WARRANTY IS LIMITED TO THE REPAIR OR REPLACEMENT PROVIDED ABOVE AND, IN NO EVENT, SHALL THE COMPANY'S LIABILITY EXCEED THE PURCHASE PRICE PAID BY PURCHASER FOR THE PRODUCT.

This Warranty is in lieu of all other express warranties or liabilities. ANY IMPLIED WARRANTIES, INCLUDING ANY IMPLIED WARRANTY OF MERCHANTABILITY, SHALL BE LIMITED TO THE DURATION OF THIS WRITTEN WARRANTY. ANY ACTION FOR BREACH OF ANY WARRANTY HEREUNDER INCLUDING ANY IMPLIED WARRANTY OF MERCHANTABILITY MUST BE BROUGHT WITHIN A PERIOD OF 12 MONTHS FROM DATE OF ORIGINAL PURCHASE. IN NO CASE SHALL THE COMPANY BE LIABLE FOR ANY CONSEQUENTIAL OR INCIDENTAL DAMAGES FOR BREACH OF THIS OR ANY OTHER WARRANTY, EXPRESS OR IMPLIED, WHATSOEVER. No person or representative is authorized to assume for the Company any liability other than expressed herein in connection with the sale of this product.

Some states do not allow limitations on how long an implied warranty lasts or the exclusion or limitation of incidental or consequential damage so the above limitations or exclusions may not apply to you. This Warranty gives you specific legal rights and you may also have other rights which vary from state to state.

U.S.A: 1-800-323-4815

CANADA: Call 1-800-323-4815 for location of warranty station serving your area.

Audiovox Electronics Corporation  
Hauppauge, NY 11788  
Technical Assistance: 1-800-323-4815  
[www.jensen.com](http://www.jensen.com)

© 2005 Audiovox  
Ver 1.0  
Printed in China